

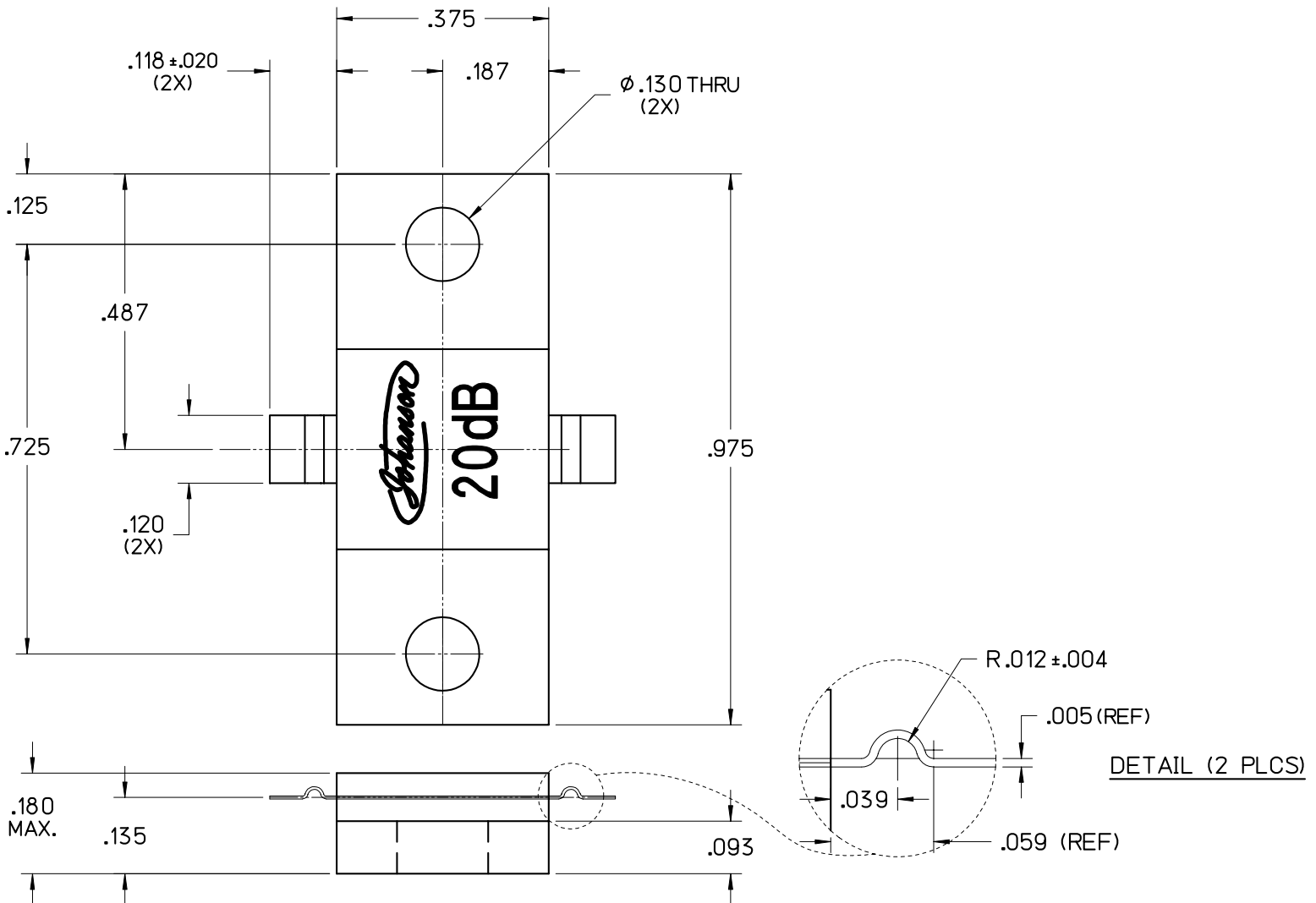

AF200A02012-480

AIN Flange Attenuator

Power: 200 Watts (CW) (135 CW max @ 140 C)
Attenuation: 20 dB \pm 1.0 dB
VSWR: 1.2 :1
Frequency Range: DC to 2.0 GHz
Substrate: AIN



For detailed information regarding this product or sample request contact Johanson Sales



Johanson Manufacturing Corporation • 301 Rockaway Valley Road, Boonton, New Jersey 07005 • Phone 973.334.2676 • Fax 973.334.2954
STAY TUNED • ELECTRONIC ACCURACY THROUGH MECHANICAL PRECISION • WWW.JOHANSONMFG.COM