

TF040BB05B

HIGH POWER BeO TERMINATION (B40B-T5)

SPECIFICATIONS

FILE: TERMOUT

POWER MAX (WATTS):	40 CW
RESISTANCE	50 OHMS (±5%)

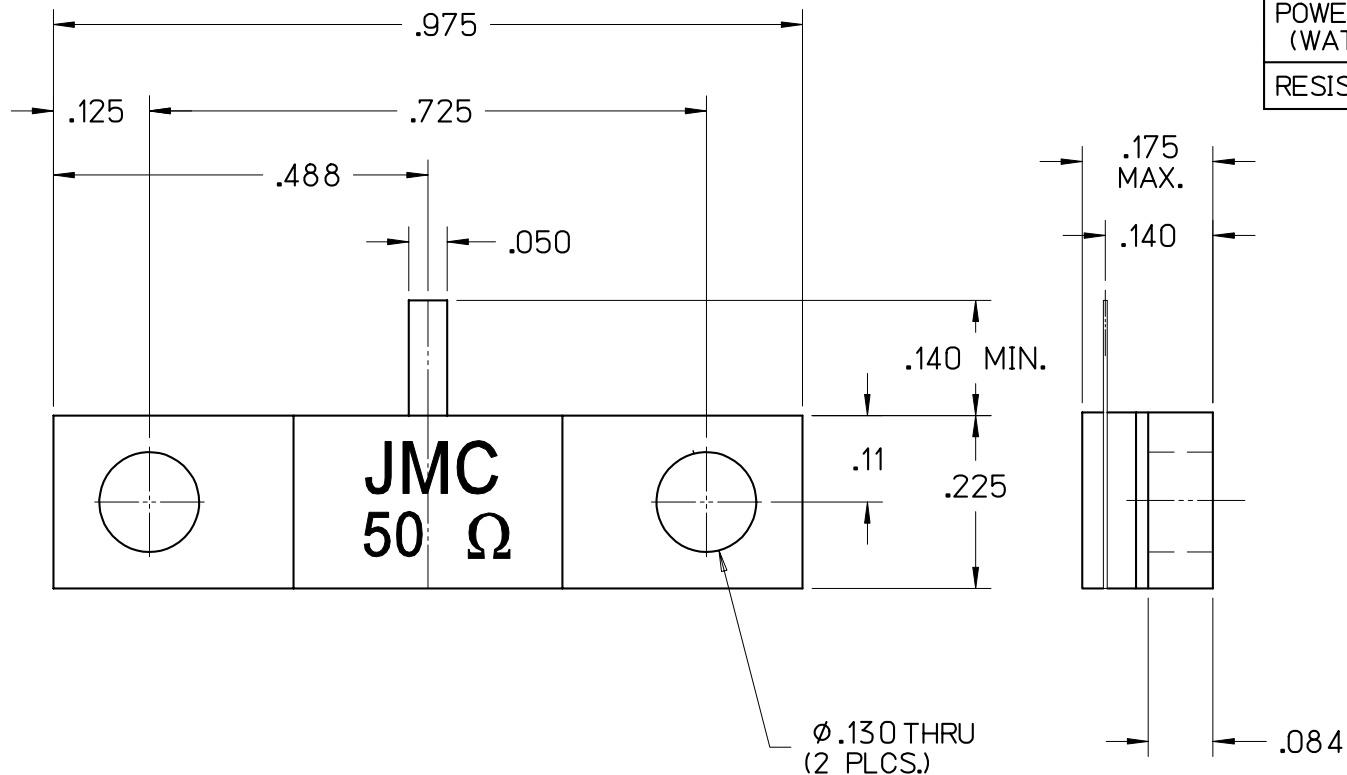

CAUTION

THIS SUBSTRATE USES BERYLLIUM OXIDE
USE CARE WHEN HANDLING.
DO NOT SCRATCH OR ABRASIVE
TRIM IN OPEN AREA.

B	10/17/06	MLD	MAI	MAI	000457
A	05/31/06	MLD	-	-	000409
LEVEL	DATE	DRN.	CHK.	APP.	ECN

REVISIONS

DRN.	CHK.	APP.	SCALE
MLD	MAI	MAI	4" = 1"
DATE	DATE	DATE	.XX ± .015
05/31/06	07/10/06	07/10/06	.XXX ± .010



JOHANSON MANUFACTURING CORPORATION
ROCKAWAY VALLEY ROAD, BOONTON, N.J. 07005 (973)334-2676 FAX (973)334-2954
ELECTRONIC ACCURACY THROUGH MECHANICAL PRECISION