



RF020AA01

AlN Flanged Resistor

Power: 20 Watts (CW)

Resistance: 100 $\Omega \pm 5\%$

Frequency Range: DC to 4 GHz

Substrate: AlN



TYPICAL PERFORMANCE

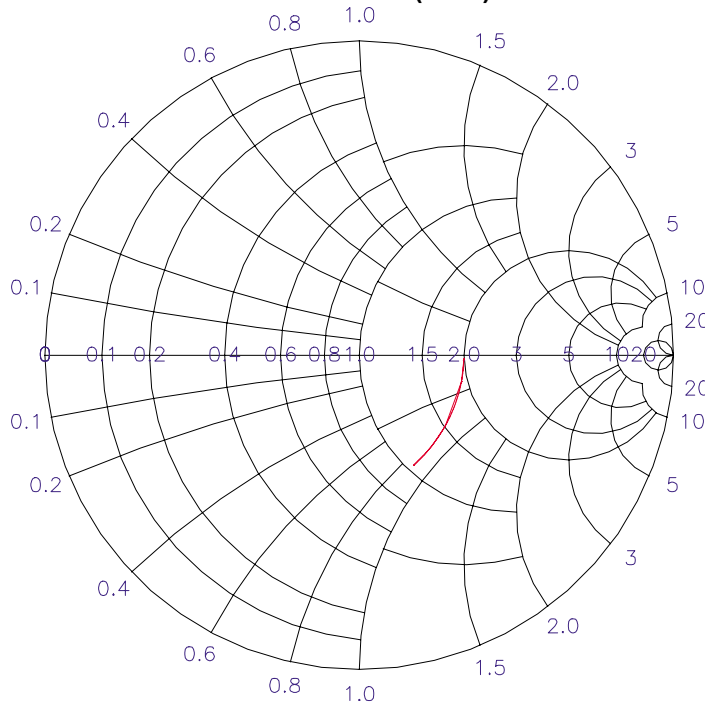
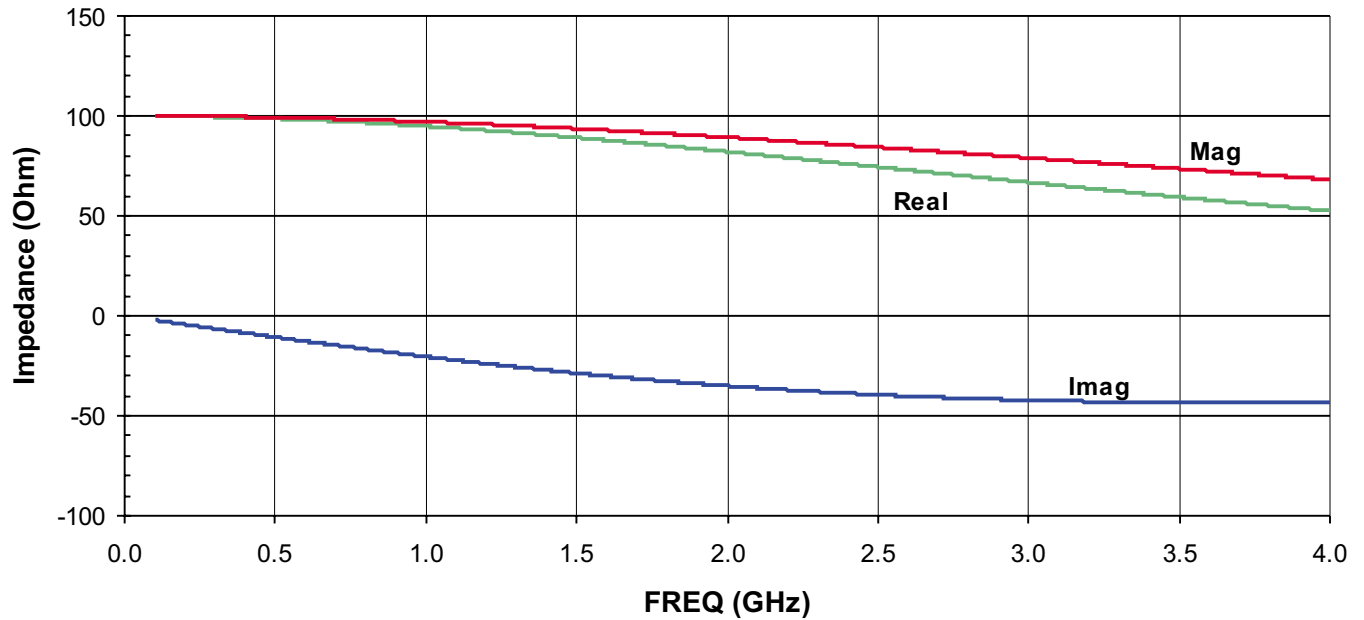

For detailed information regarding this product or sample request contact Johanson Sales



Johanson Manufacturing Corporation • 301 Rockaway Valley Road, Boonton, New Jersey 07005 • Phone 973.334.2676 • Fax 973.334.2954
STAY TUNED • ELECTRONIC ACCURACY THROUGH MECHANICAL PRECISION • WWW.JOHANSONMFG.COM



RF020AA01

AlN Flanged Resistor

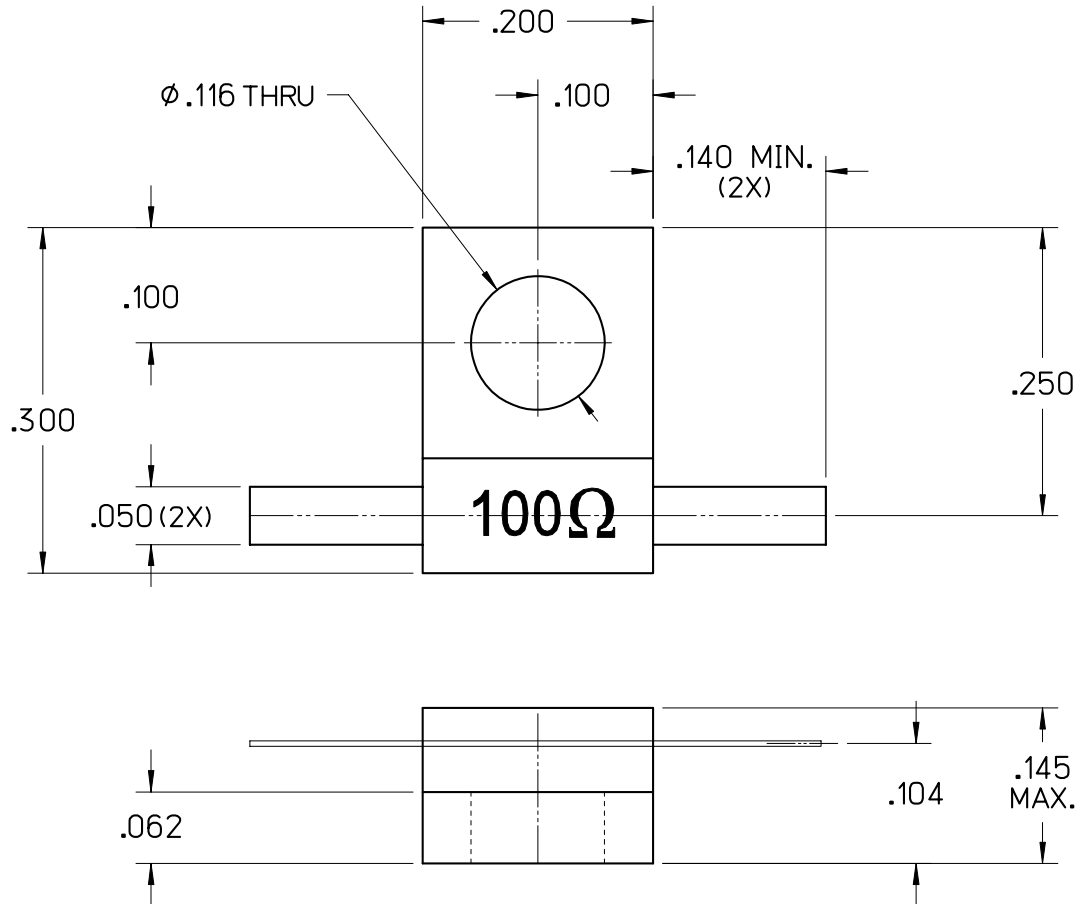

For detailed information regarding this product or sample request contact Johanson Sales



Johanson Manufacturing Corporation • 301 Rockaway Valley Road, Boonton, New Jersey 07005 • Phone 973.334.2676 • Fax 973.334.2954
STAY TUNED • ELECTRONIC ACCURACY THROUGH MECHANICAL PRECISION • WWW.JOHANSONMFG.COM

Nov 08